

# **VOLMED**

Serving Healthcare Since 1971



## **GENERAL SURGICAL INSTRUMENTS CATALOG**

[www.volmed.co.uk](http://www.volmed.co.uk)

## About Us

With over 50 years of industry experience, VOLMED is a family-owned company specializing in the supply of high-quality surgical instruments to the medical and surgical markets across the United Kingdom, Europe, and globally. Our extensive expertise enables us to assist with project research and development, ensuring that we meet the evolving needs of our clients.

Our philosophy is simple: we treat our customers as we would like to be treated, which places customer satisfaction at the forefront of our priorities. This approach naturally aligns with our commitment to delivering products of the highest quality. Ultimately, our goal is to empower you to provide the best possible care and achieve improved health outcomes by streamlining the process of stocking your practice.

We take pride in the breadth of our product offerings, understanding that sourcing medical tools and surgical instruments from multiple suppliers can be both time-consuming and challenging. To address this, we strive to be your one-stop shop for all your requirements.

## Our History

Our story began over 50 years ago within a family deeply rooted in the medical instrument manufacturing industry. The foundation of our thriving business was built by a team of highly ambitious professionals with expertise in producing plastic surgery, dental and surgical instruments.

Inspired by the potential for excellence, our founder established VOLMED, a company dedicated to providing outstanding customer service and high-quality products. Since then, our team of dedicated professionals has worked tirelessly to ensure that customers worldwide receive only the finest surgical instruments and related services. We never compromise on quality, continually investing in our team, resources, equipment, and processes. Every detail is meticulously examined to ensure we can adapt to changing demands while maintaining the highest standards of quality.

## Our Promise

At VOLMED, our commitment to excellence is unwavering. We strive to achieve the highest standards in everything we do, working relentlessly to provide exceptional service to our customers and everyone associated with our company. We view it as our responsibility to contribute to a better future for the entire community, and we are dedicated to making this vision a reality.

## **Quality**

Our commitment to quality is reflected in our CE and UKCA-marked instruments, manufactured in accordance with stringent global quality assurance standards, including ISO 9001:2015, ISO 13485:2016, and the Medical Device Directive 93/42/EEC.

## **Our Mission**

We are committed to manufacturing and supplying products that meet the highest standards of strength, accuracy, and reliability. Recognizing the critical role our equipment plays in saving lives and improving health, we take this responsibility seriously. Our mission is to simplify the procurement process by offering a comprehensive range of high-quality surgical products under one roof.

## **Products**

At VOLMED, surgical instruments are at the core of our offerings. We provide a wide range of high-quality surgical products suitable for use in operating rooms, wards, veterinary practices, dentistry, and chiropody. Our instruments are crafted to strict standards using a blend of modern technology and traditional craftsmanship, in full compliance with the Medical Devices Directive 93/42/EEC. Complete traceability is maintained throughout the manufacturing process.

To ensure exceptional product performance and reliability, all our products undergo rigorous engineering analysis and stringent inspection methods. VOLMED instruments are guaranteed for five years against manufacturing defects and are made from premium surgical-grade stainless steel, in accordance with ISO 7153-1:2016 specifications. Explore our product listings and catalogues to discover our comprehensive range of surgical instruments.

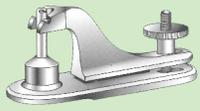

# Urology Instruments



Serving Healthcare Since 1971

## Urology

Serving Healthcare Since 1971

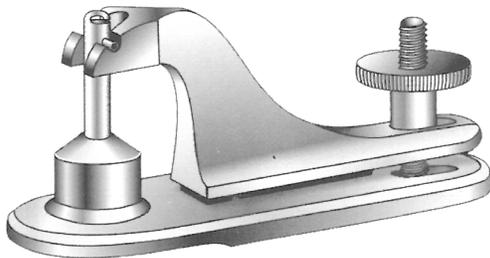

**38**

**38**



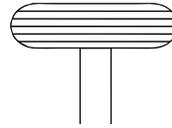

V-037-469  
23 cm / 9"

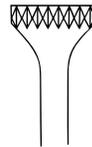

V-037-471  
23 cm / 9"

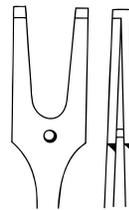

V-037-472  
24 cm / 9½"

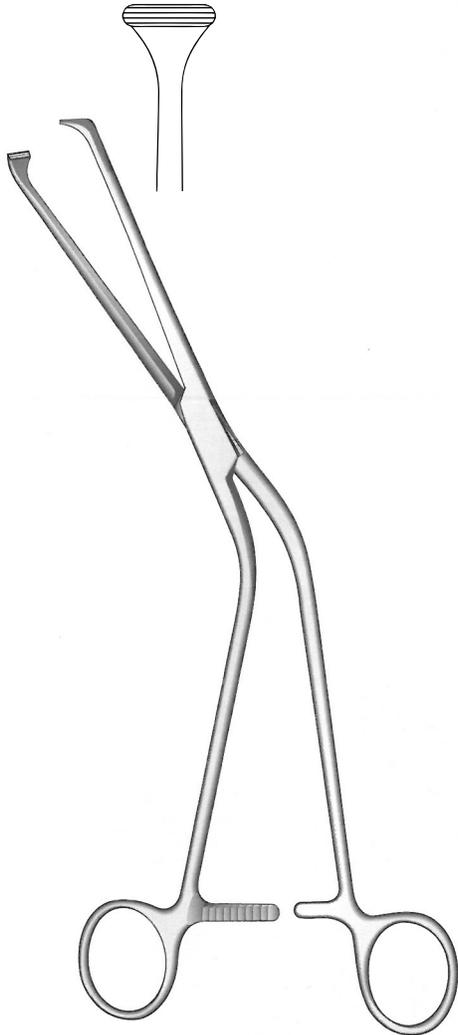

Millin  
V-037-468  
24.5 cm / 9¾"

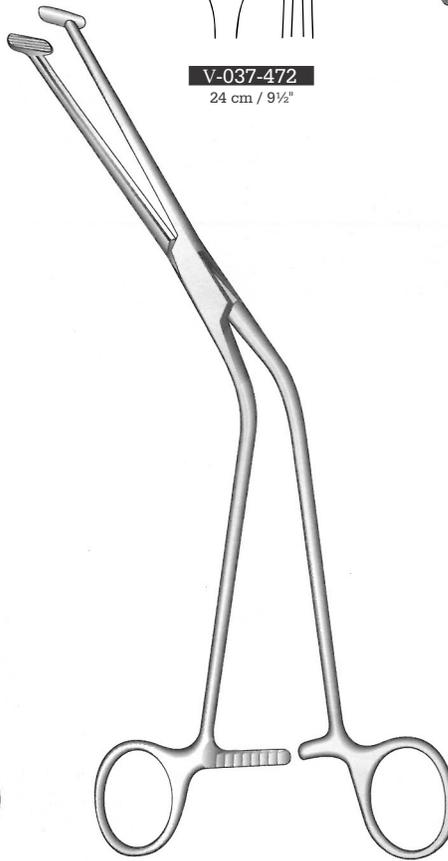

Millin

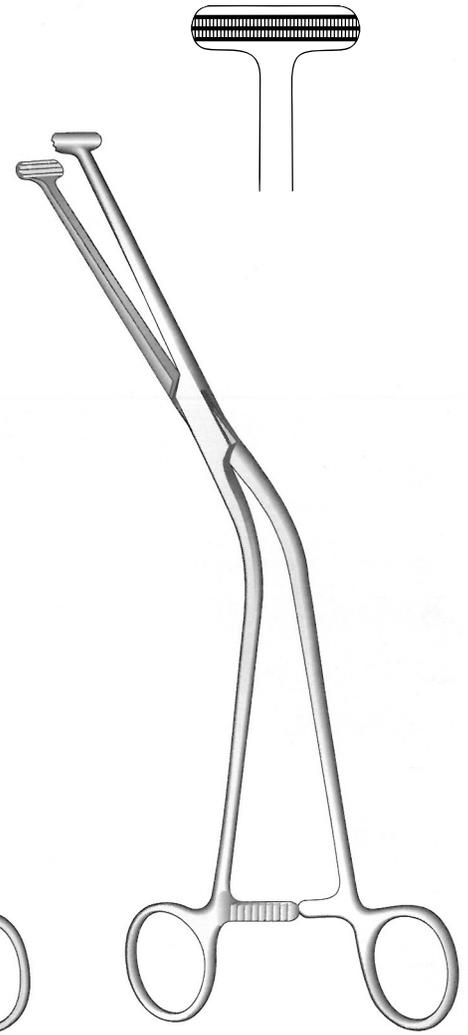

Millin  
V-037-473  
23.5 cm / 9¼"

# Urology

Bladder Retractors  
Blasen-Wundseizer  
Separadores vesivales

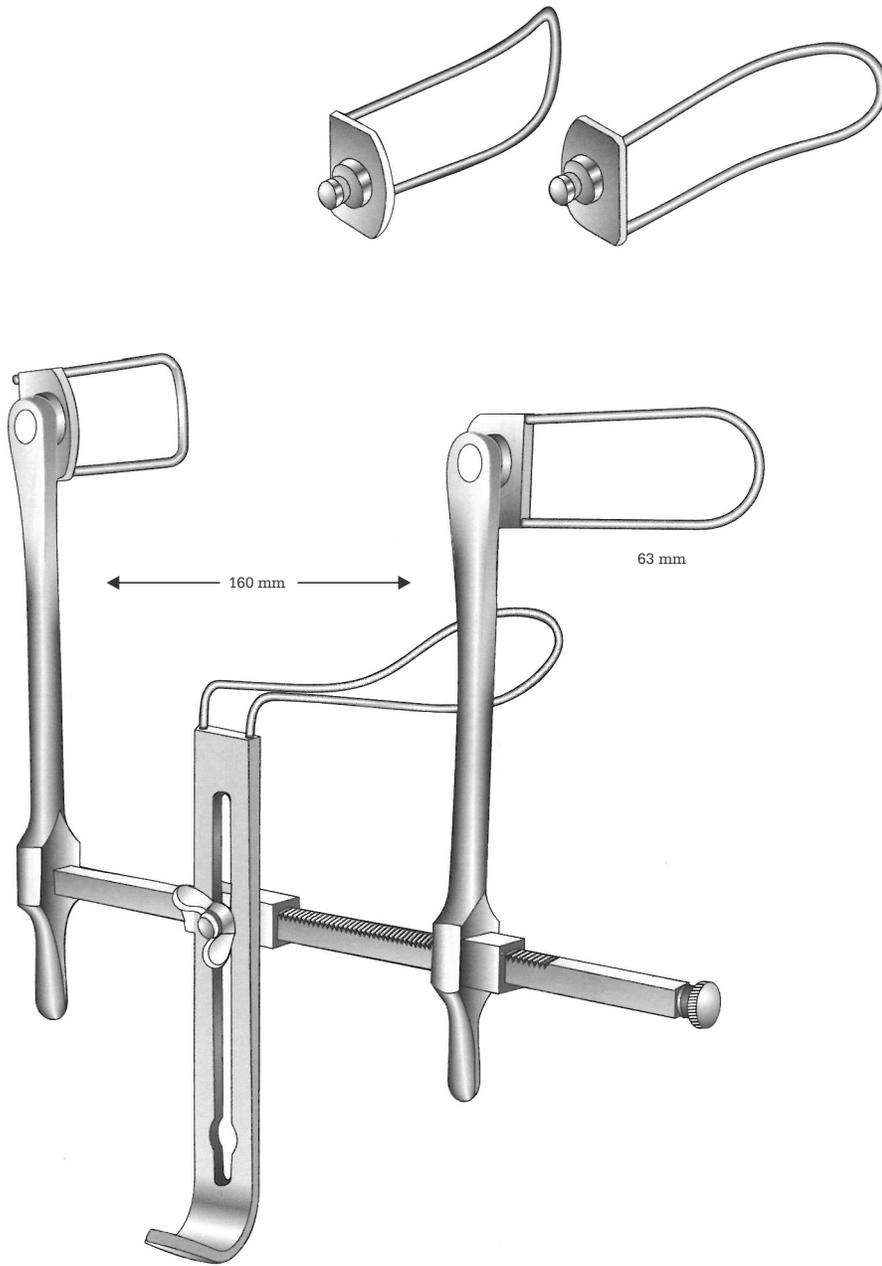

Gosset  
V-038-080

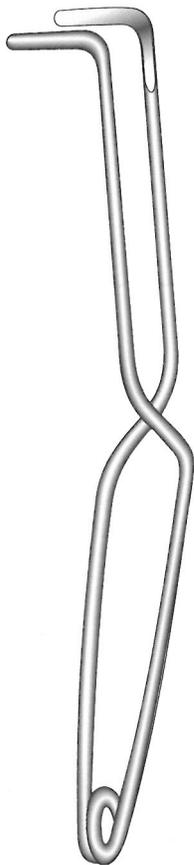

Millin  
V-038-130  
25 cm / 9¾"

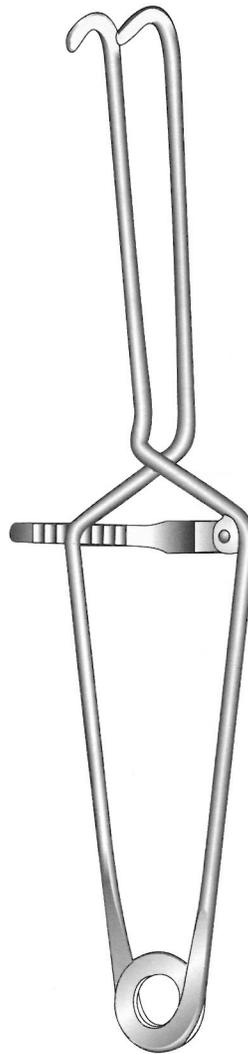

Millin  
V-038-140  
29 cm / 11½"

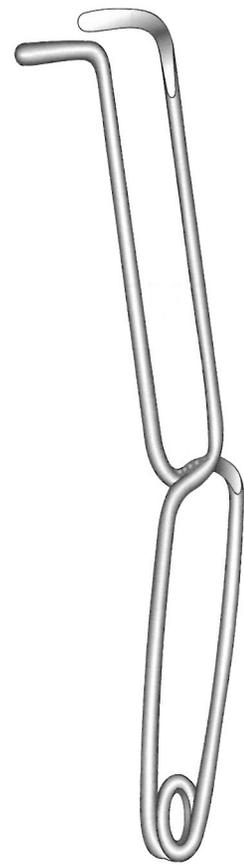

Millin  
V-038-150  
25 cm / 9¾"

# Urology

Bladder Retractors  
Blasenwundsperrer  
Separadores vesicales

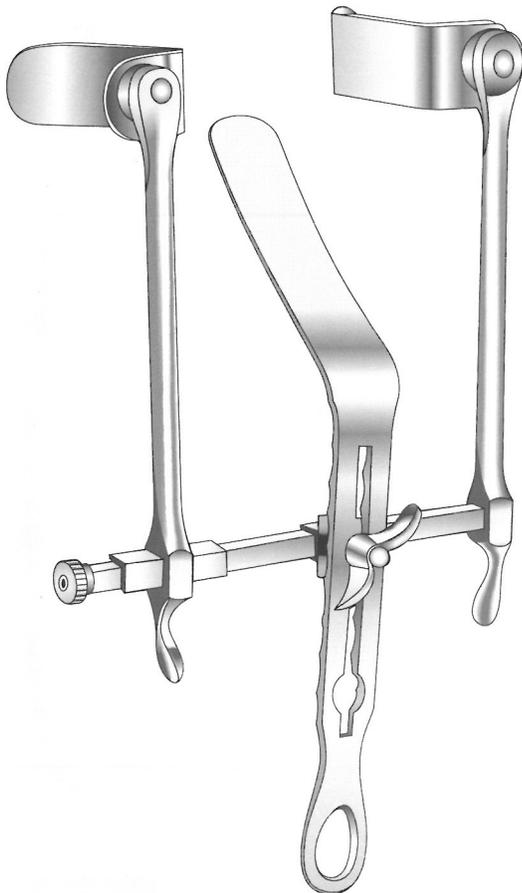
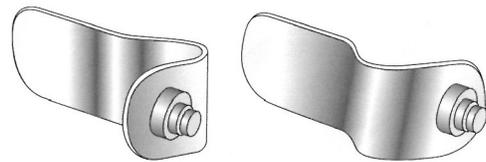

Thomson-Walker  
V-038-090

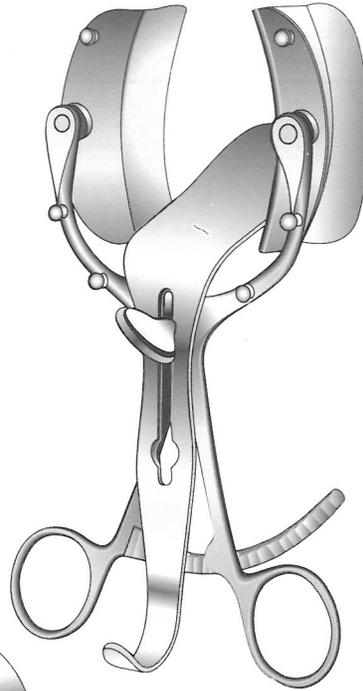

Legueu  
V-038-110

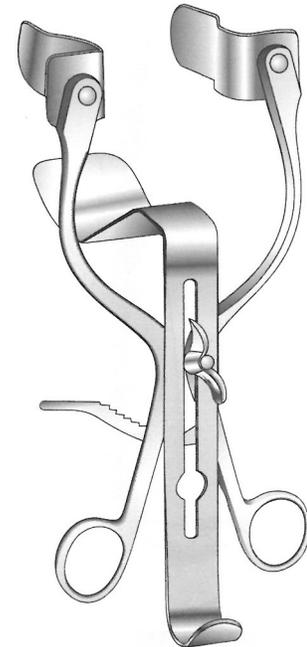
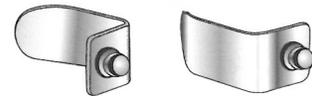

Millin  
V-038-120



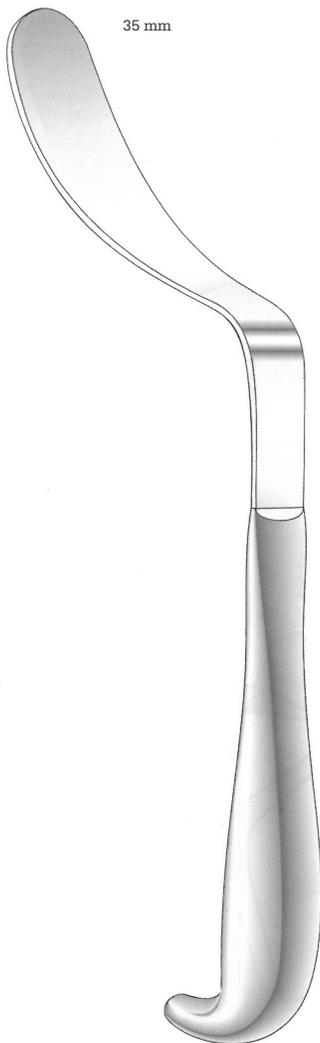

Legueu  
V-038-151  
27 cm / 10½"

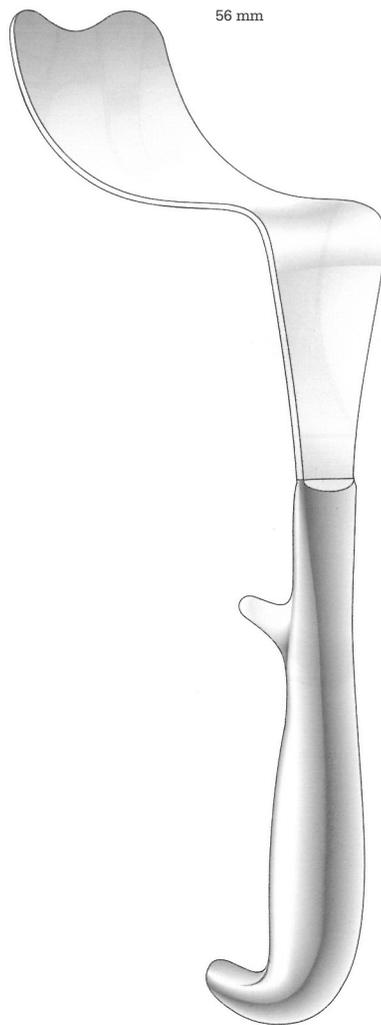

Kocher  
V-038-152  
26 cm / 10¼"



Kocher  
V-038-153  
26 cm / 10¼"

# Urology

Foreign Body Forceps & Circumcision Instruments  
 Fremdkörperzangen und Circumcisions-instrumentes  
 Pinzas para cuerois extrabos Y circuncision

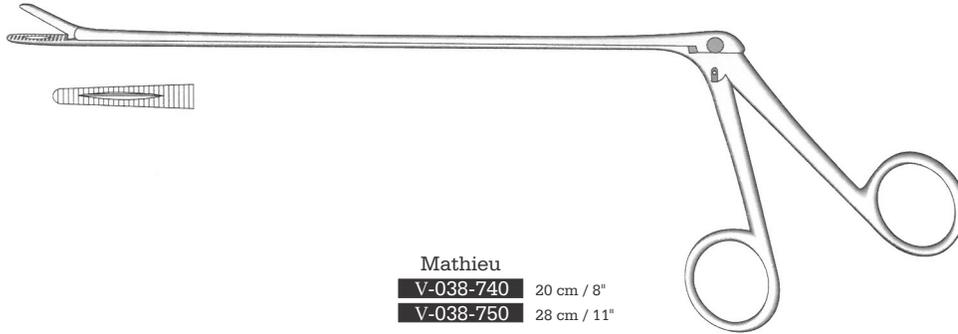

**Mathieu**  
**V-038-740** 20 cm / 8"  
**V-038-750** 28 cm / 11"

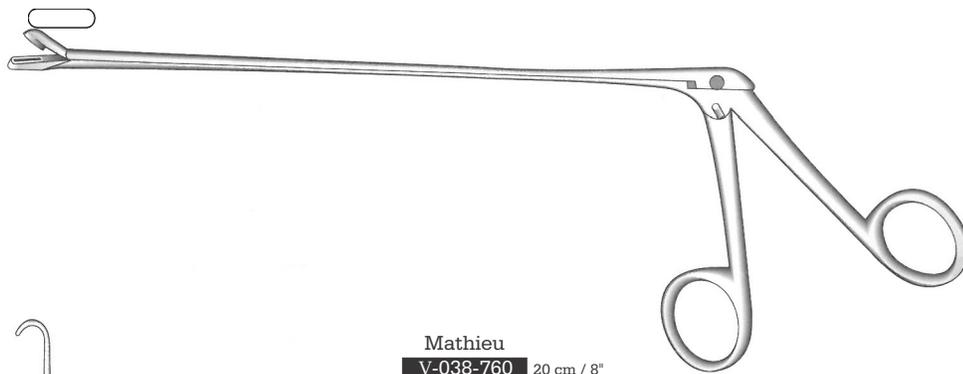

**Mathieu**  
**V-038-760** 20 cm / 8"  
**V-038-770** 28 cm / 11"

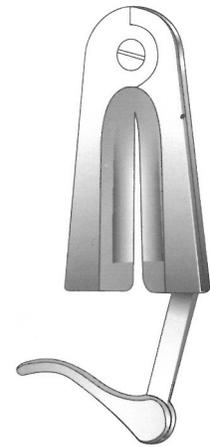

**Mogen**  
**V-038-844**  
 7 cm / 2 3/4"



**V-038-775**  
 16 cm / 6 1/4"

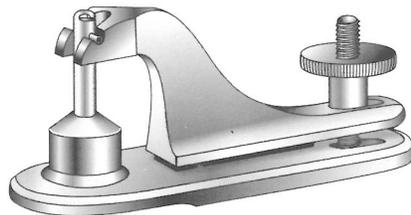

**V-038-780** 8 mm Ø  
**V-038-790** 11 mm Ø  
**V-038-800** 13 mm Ø  
**V-038-810** 16 mm Ø  
**V-038-820** 21 mm Ø  
**V-038-830** 26 mm Ø  
**V-038-840** 32 mm Ø

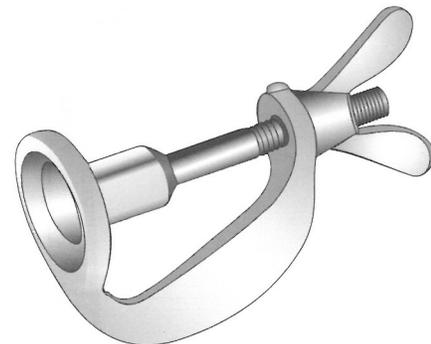

**Winkelmann**  
**V-038-841** 12 mm Ø  
**V-038-842** 16 mm Ø  
**V-038-843** 20 mm Ø  
 Circumcision clamps



Child  
V-038-160



Key  
V-038-170



Teale  
V-038-180

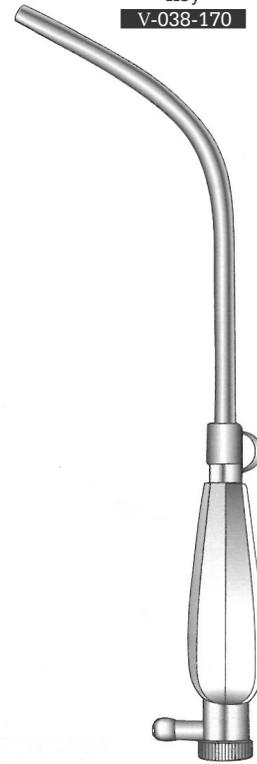

Millin  
V-038-190

# Urology

Lithotomy Forceps and Penis Clamp

Steinzangen Und Penisklemmen

Pinza/litotomia y Compresores Uretrales



Lewkowitz  
V-038-200  
26 cm / 10 1/4"

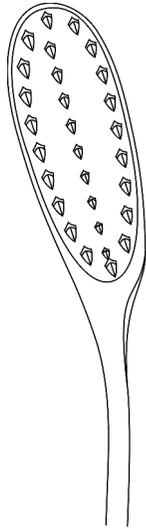

V-038-210  
Angled

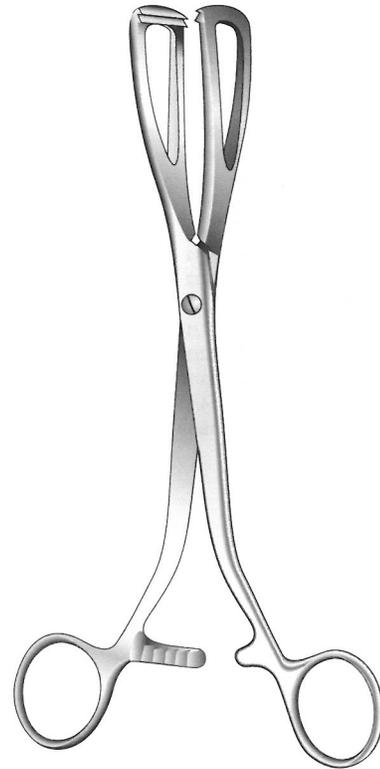

Young  
V-038-211  
20 cm / 8"



Thomson-Walker  
V-038-220

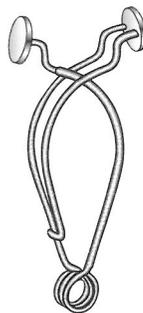

Stockmann  
V-038-221

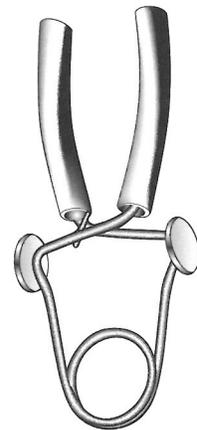

Strauss  
V-038-222

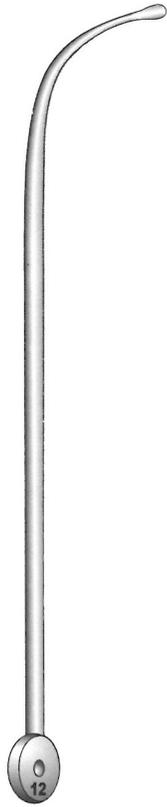

Lister  
V-038-900  
Set

	Fr.
V-038-910	00/1
V-038-1000	0/2
V-038-1010	1/3
V-038-1020	1/4
V-038-1030	2/5
V-038-1040	3/6
V-038-1050	4/7
V-038-1060	5/8
V-038-1070	6/9
V-038-1080	7/10
V-038-1090	8/11
V-038-1100	9/12
V-038-1110	10/13
V-038-1120	11/14
V-038-1130	12/15
V-038-1140	13/16
V-038-1150	14/17
V-038-1160	15/18



Clutton  
V-038-920  
Set

	Fr.
V-038-930	6/10
V-038-940	8/12
V-038-950	10/14
V-038-960	12/16
V-038-970	14/18
V-038-980	16/20
V-038-990	18/22
V-038-1180	20/24
V-038-1190	22/26
V-038-1200	24/28
V-038-1210	26/30
V-038-1220	28/32



	Fr.
V-038-850	06
V-038-860	08
V-038-870	10
V-038-880	12



Dittel  
V-038-890  
Set

	Fr.
V-038-1900	8
V-038-1901	9
V-038-1902	10
V-038-1903	11
V-038-1904	12
V-038-1905	13
V-038-1906	14
V-038-1907	15
V-038-1908	16
V-038-1909	17
V-038-1910	18
V-038-1911	19
V-038-1912	20
V-038-1913	21
V-038-1914	22
V-038-1915	23
V-038-1916	24
V-038-1917	25
V-038-1918	26
V-038-1919	27
V-038-1920	28
V-038-1921	29
V-038-1922	30

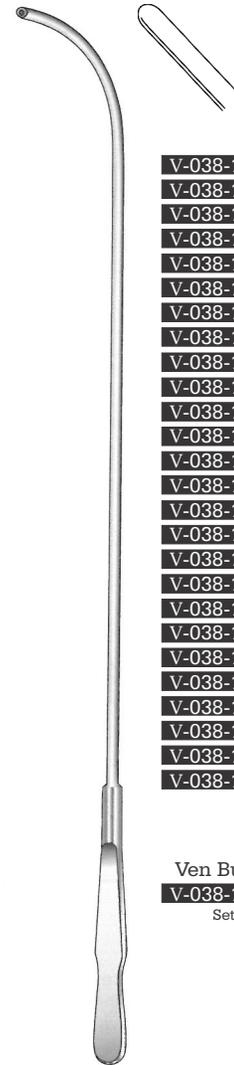

Ven Buren  
V-038-1250  
Set

	Fr.
V-038-1221	8
V-038-1222	9
V-038-1223	10
V-038-1224	11
V-038-1225	12
V-038-1226	13
V-038-1227	14
V-038-1228	15
V-038-1229	16
V-038-1230	17
V-038-1231	18
V-038-1232	19
V-038-1233	20
V-038-1234	21
V-038-1235	22
V-038-1236	23
V-038-1237	24
V-038-1238	25
V-038-1239	26
V-038-1240	27
V-038-1241	28
V-038-1242	29
V-038-1243	30
V-038-1244	32
V-038-1245	34
V-038-1246	36

# Urology

Dilating Bougies  
Dilatationsbougies  
Bugiasdilator



	Fr.	
V-038-1821	08	V-038-1460
V-038-1822	09	V-038-1470
V-038-1823	10	V-038-1480
V-038-1824	11	V-038-1490
V-038-1825	12	V-038-1500
V-038-1826	13	V-038-1510
V-038-1827	14	V-038-1520
V-038-1828	15	V-038-1530
V-038-1829	16	V-038-1540
V-038-1830	17	V-038-1550
V-038-1831	18	V-038-1560
V-038-1832	19	V-038-1570
V-038-1833	20	V-038-1580
V-038-1834	21	V-038-1590
V-038-1835	22	V-038-1600
V-038-1836	23	V-038-1610
V-038-1837	24	V-038-1620
V-038-1838	25	V-038-1630
V-038-1839	26	V-038-1640
V-038-1840	27	V-038-1650
V-038-1841	28	V-038-1660
V-038-1842	29	V-038-1670
V-038-1843	30	V-038-1680
V-038-1844	31	V-038-1690
V-038-1845	32	V-038-1700
V-038-1846	33	V-038-1710
V-038-1847	34	V-038-1720
V-038-1848	35	V-038-1730
V-038-1849	36	V-038-1740

With hole

Without hole

Guyon

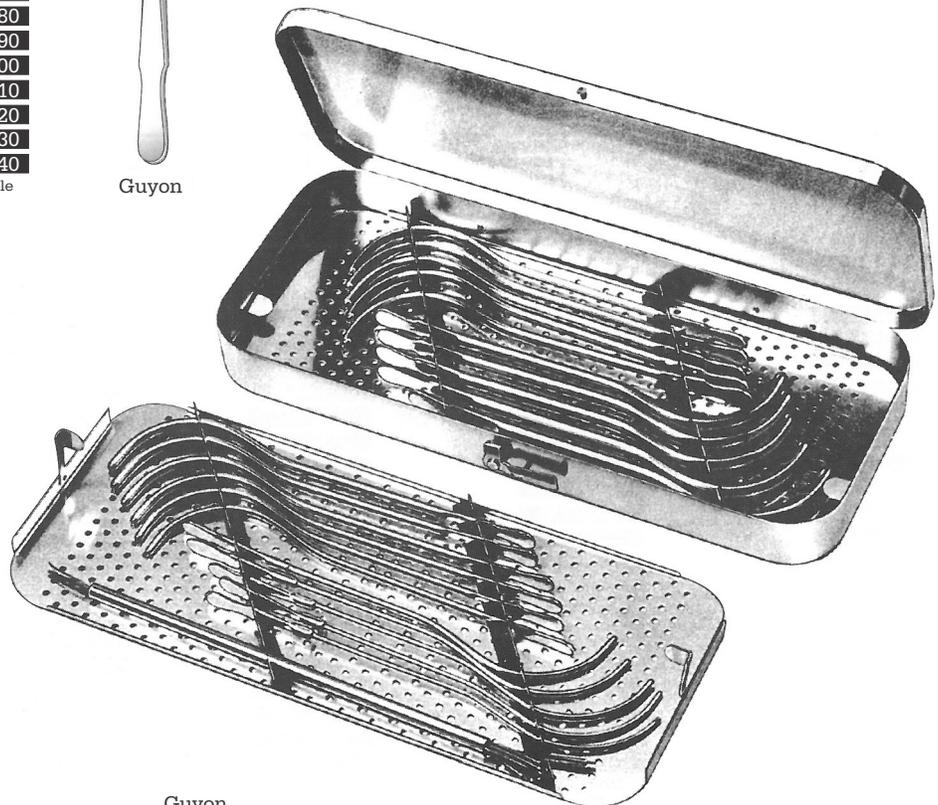

Guyon

V-038-1450 Set of 29 with hole, Fr. 8 - Fr. 36

V-038-1451 Set of 29 without hole, Fr. 8 - Fr. 36

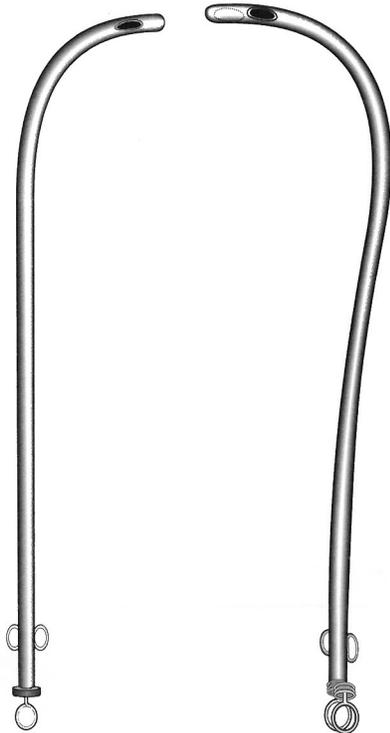

### Male

V-038-230	Fig. 06
V-038-235	Fig. 07
V-038-240	Fig. 08
V-038-245	Fig. 09
V-038-250	Fig. 10
V-038-255	Fig. 11
V-038-260	Fig. 12
V-038-265	Fig. 13
V-038-270	Fig. 14
V-038-275	Fig. 15
V-038-280	Fig. 16
V-038-285	Fig. 17
V-038-290	Fig. 18
V-038-295	Fig. 19
V-038-300	Fig. 20
V-038-305	Fig. 21
V-038-310	Fig. 22
V-038-315	Fig. 23
V-038-320	Fig. 24

27 cm / 10½"



### Coxeter

V-038-430	Fig. 06
V-038-435	Fig. 07
V-038-440	Fig. 08
V-038-445	Fig. 09
V-038-450	Fig. 10
V-038-455	Fig. 11
V-038-460	Fig. 12
V-038-465	Fig. 13
V-038-470	Fig. 14
V-038-475	Fig. 15
V-038-480	Fig. 16
V-038-485	Fig. 17
V-038-490	Fig. 18
V-038-495	Fig. 19
V-038-500	Fig. 20
V-038-505	Fig. 21
V-038-510	Fig. 22
V-038-515	Fig. 23
V-038-520	Fig. 24

28 cm / 11"



### Female

V-038-530	Fig. 06
V-038-535	Fig. 07
V-038-540	Fig. 08
V-038-545	Fig. 09
V-038-550	Fig. 10
V-038-555	Fig. 11
V-038-560	Fig. 12
V-038-565	Fig. 13
V-038-570	Fig. 14
V-038-575	Fig. 15
V-038-580	Fig. 16
V-038-585	Fig. 17
V-038-590	Fig. 18
V-038-595	Fig. 19
V-038-600	Fig. 20
V-038-605	Fig. 21
V-038-610	Fig. 22
V-038-615	Fig. 23
V-038-620	Fig. 24

15 cm / 6"



### Female

V-038-630	Fig. 06
V-038-635	Fig. 07
V-038-640	Fig. 08
V-038-645	Fig. 09
V-038-650	Fig. 10
V-038-655	Fig. 11
V-038-660	Fig. 12
V-038-665	Fig. 13
V-038-670	Fig. 14
V-038-675	Fig. 15
V-038-680	Fig. 16
V-038-685	Fig. 17
V-038-690	Fig. 18
V-038-695	Fig. 19
V-038-700	Fig. 20
V-038-705	Fig. 21
V-038-710	Fig. 22
V-038-715	Fig. 23
V-038-720	Fig. 24

20 cm / 8"

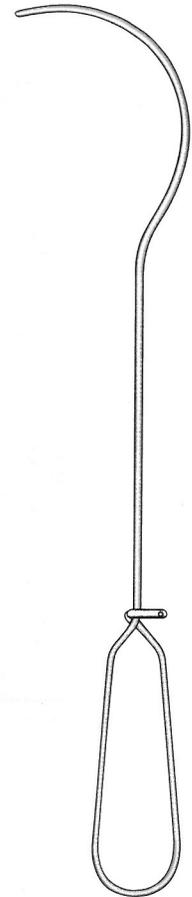

V-038-731  
35 cm / 13¾"



### Guyon

V-038-730  
39 cm / 15½"



Serving Healthcare Since 1971

---

## CONTACT US

Creative Industries Centre,  
Glaisher Drive Wolverhampton Science Park,  
Wolverhampton United Kingdom,  
WV10 9TG

**Email queries:**

[info@volmed.co.uk](mailto:info@volmed.co.uk) / [sales@volmed.co.uk](mailto:sales@volmed.co.uk)

[www.volmed.co.uk](http://www.volmed.co.uk)